	$\approx 4.0 \times 13 \text{mm}$ 			
16	16	40-50	4	1	2	22	4	4	3

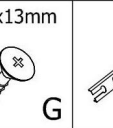

Produkt nie jest odporny na działanie wilgoci, przeznaczony do pomieszczeń suchych.
The product is not resistant to moisture, intended for dry rooms.

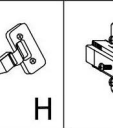

2.

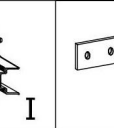
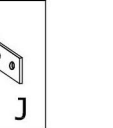
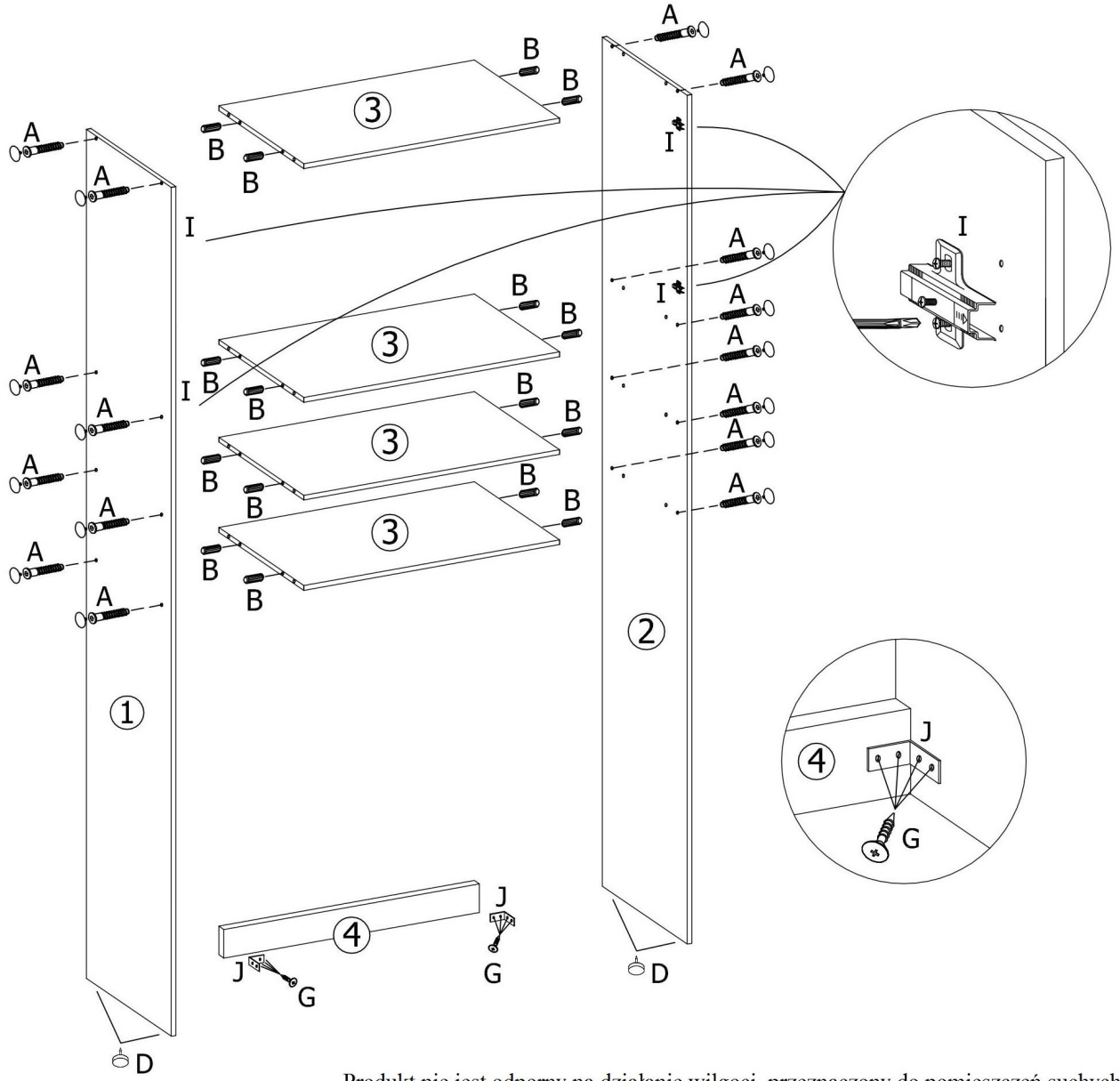
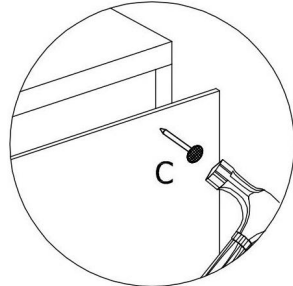
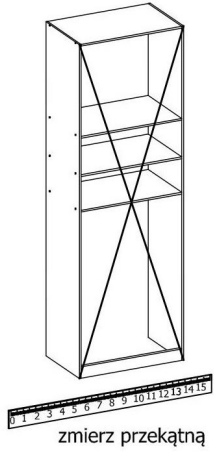
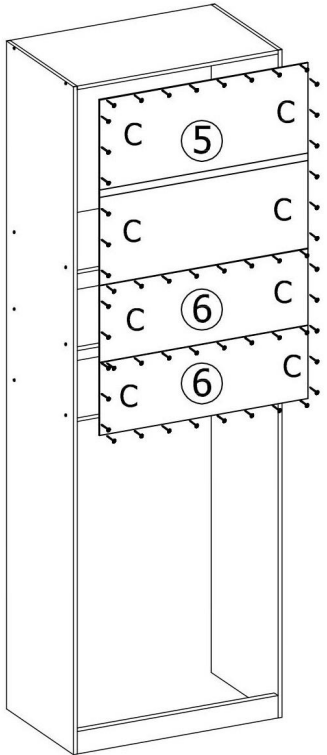
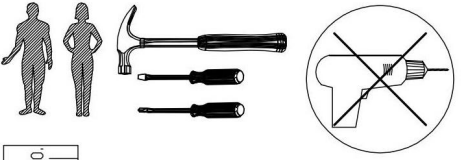
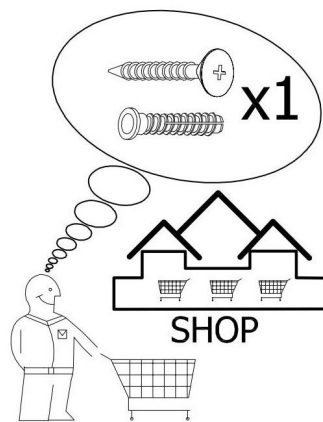
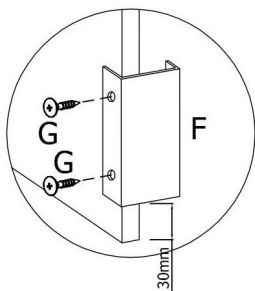
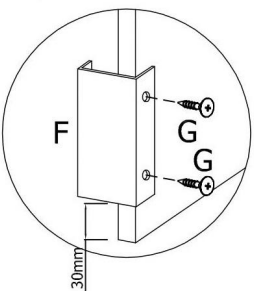
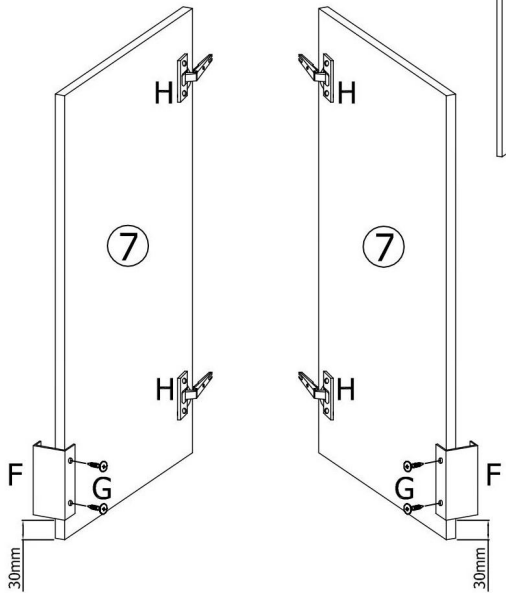
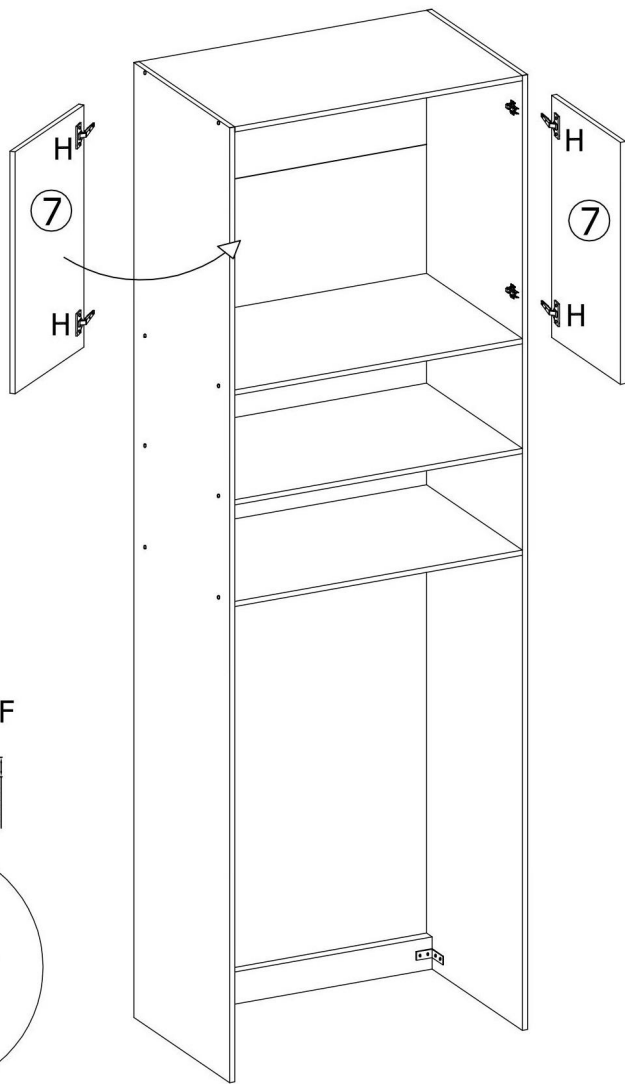
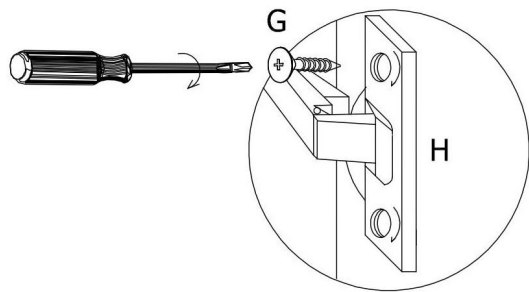
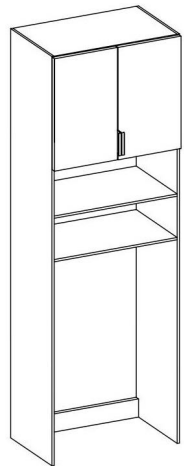
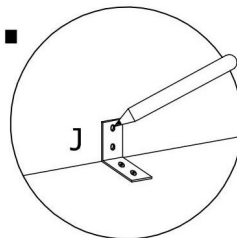

3.

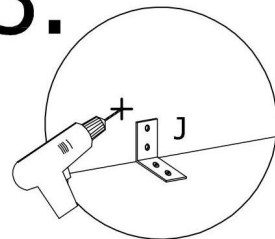

4.

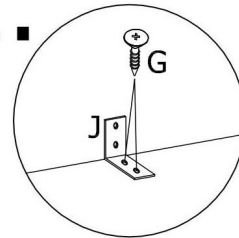
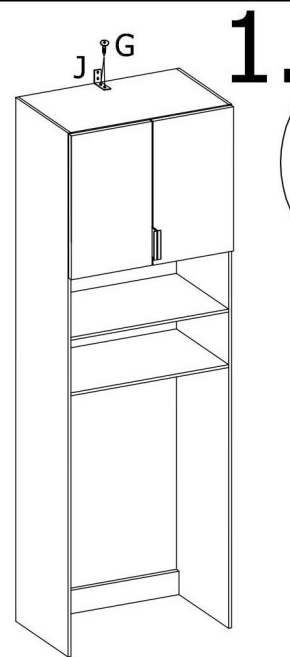
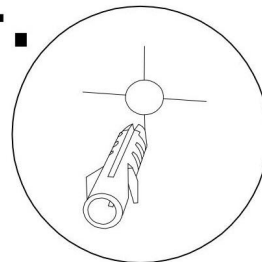

5.

